



*Le succès dans l'art de vos déplacements*

# Roues & Roulettes

# Sommaire

## Généralités

Roues et Roulettes à bandage Caoutchouc PAGE 8



Roues et Roulettes à bandage Polyamide PAGE 32



Roues et Roulettes à bandage Polyuréthane PAGE 48



Roues et Roulettes Inox PAGE 72



Roues et Roulettes HT°, Fonte, Gonflable, Embouts.. PAGE 84



Roues Motrices, Stabilisatrices, Galets.. PAGE 106



Roues et Roulettes Collectivités PAGE 116



## Index des références

# Généralités

## Déterminer la charge par roue ou roulette

Si votre chariot est équipé de 4 roulettes, nous vous conseillons de diviser par 3 la charge TOTALE. Vous aurez ainsi la charge subie par une roue ou une roulette.

Les charges unitaires de ce catalogue sont données pour :

- Une vitesse maxi de 4km/h
  - Une température ambiante comprise entre +5°C et 25°C
- Sauf indications mentionnées.

## Déterminer le diamètre d'une roue

Le diamètre est choisi le plus grand possible pour minimiser l'effort de démarrage et de roulage. Il facilite le passage des éventuels obstacles et réduit les contraintes sur le sol.

## Déterminer le type de bandage de la roue

- Le bandage peut être souple.  
Exemple le Caoutchouc noir ou gris, le Polyuréthane 80 shores A.  
Il permet une manutention silencieuse. Le passage des obstacles est plus aisé. L'effort de démarrage est réduit.
- Le bandage peut être dur.  
Exemple le Polyamide ou le Polyuréthane 95 shores A.  
Il permet un démarrage facile sur sol lisse et une grande facilité de roulage.
- Le bandage peut être Pneumatique.  
Exemple les roues gonflables, il permet une utilisation sur terrain accidenté.

## Déterminer le moyeu de la roue

- Moyeu lisse.  
Solution économique. Utilisation sans conditions particulières avec des contraintes faibles.
- Moyeu à rouleaux.  
Idéal pour la manutention manuelle. Effort de démarrage réduit.
- Moyeu à billes.  
Pour les charges élevées et l'usage intensif.  
Recommandé pour un usage tracté. Effort de démarrage faible.

# Généralités

## Déterminer le type de monture

- Fixe : Permet d'être précis dans la trajectoire du chariot
- Pivotante : Permet une grande maniabilité du chariot
- A blocage : Blocage double effet sur roue et pivot permet l'immobilisation totale du chariot
- A blocage directionnel : Permet de rendre **fixe** une roulette **pivotante**
- Utilisé dans les fortes charges. Précision du parcours

## Déterminer le type de fixation

- A platine rectangulaire ou carrée pour un montage sur une surface plane.
- A oeil pour un montage par une vis centrale dans un tube.
- A tige filetée, tige lisse ou fixation expansible ronde ou carrée.

## Déterminer la matière de la monture

- Zinguée : Usage économique et courant dans un environnement standard.
- Inox : Utilisation en milieu agressif ou en agro-alimentaire, pharmaceutique etc..
- Emboutie forte épaisseur : Permet une charge lourde et de grosses contraintes
- Mécano-soudée : Utilisation intensive et exigeante, charge très lourde

Malgré tout le soin apporté à ce catalogue et le système qualité que nous avons mis en place afin d'améliorer nos produits, cela peut entraîner la modification des côtes de ce catalogue.  
Les côtes ou photos sont donc non contractuelles

## Symboles

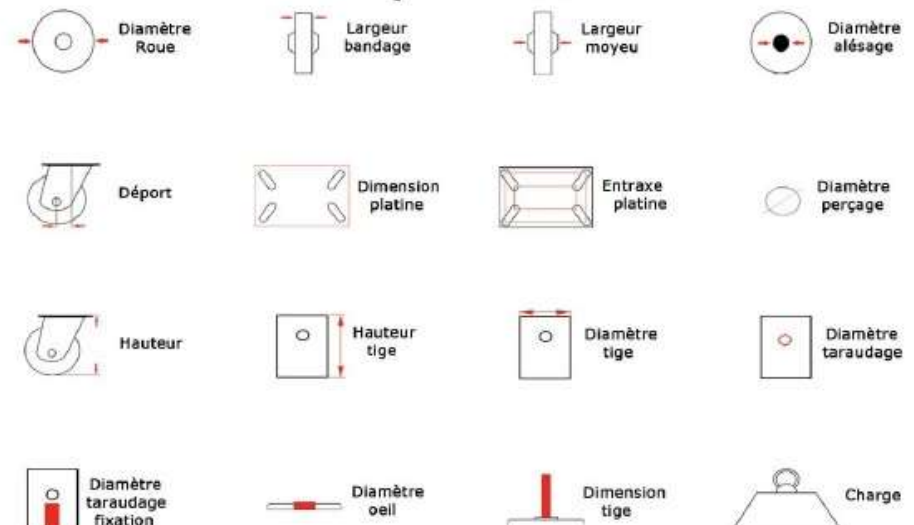

# PRINCIPALES RESISTANCES AUX AGRESSIONS

	CAOUTCHOUC STANDARD	CAOUTCHOUC ELASTIQUE	POLYAMIDE	POLYURETHANE
ACETONE	●	●	●	●
ACIDE SULFURIQUE à 10%	●	●	●	●
AMMONIAQUE	●	●	●	●
EAU à 20°C	●	●	●	●
EAU DE MER	●	●	●	●
EAU à 80°C	●	●	●	●
ESSENCE	●	●	●	●
GASOIL	●	●	●	●
GLYCERINE	●	●	●	●
HUILE DE LIN	●	●	●	●
HUILE MINERALE	●	●	●	●
HUILE MOTEUR	●	●	●	●
HUILE D'OLIVE	●	●	●	●
HUILE DE SOJA	●	●	●	●
LAIT	●	●	●	●
PETROLE	●	●	●	●
TEREBENTHINE	●	●	●	●
COPEAUX METALLIQUES	●	●	●	●

## Légende

- : Conseillée
- : Partiellement résistante
- : Déconseillée



Roulette Pivotante  
en Aluminium / Caoutchouc



Roulette Pivotante  
à **Frein Avant**  
en Aluminium / Polyuréthane



Roulette Pivotante  
à **Frein Arrière**  
en Fonte / Polyuréthane



Roulette Fixe  
en Polyamide



Roulette Pivotante  
à Oeil  
en Caoutchouc Noir



Roulette Pivotante  
à Frein à Oeil  
en Caoutchouc Gris

# ROULETTE INDUSTRIELLE

## Roue Caoutchouc Noir

Capacité de charge de 50 à 300 Kgs

Monture à platine en tôle zinguée  
 Pivotement sur 2 couronnes de billes protégé  
 Blocage avant à double effet sur roue et pivot  
 Roue à bandage caoutchouc noir  
 Corps de roue en plastique  
 Moyeu à rouleaux  
 Axe démontable  
 Température d'utilisation de -10°C à +60°C



50	65	25	66x49	54x32	6	35
65	85	30	70x55	56x43	8	50
80	100	36	105x80	80x60	9	50
100	125	38	105x80	80x60	9	70
125	155	48	105x80	80x60	11	100
125	155	48	135x110	105x80	11	100
160	190	52	135x110	105x80	11	135
200	235	54	135x110	105x80	11	205
250	290	66	135x110	105x80	11	295

SMP610	SMF610	-
SMP620	SMF620	-
SMP630	SMF630	SMB630
SMP640	SMF640	SMB640
SMP650	SMF650	SMB650
SMP651	SMF651	SMB651
SMP661	SMF661	SMB661
SMP671	SMF671	SMB671
SMP681	SMF681	SMB681



80	25	12	40	50
100	30	12	40	70
125	38	15	50	100
160	40	20	60	135
160	40	25	60	135
200	50	20	60	205
200	50	25	60	205
250	50	20	60	250
250	50	25	60	250

SR6301
SR6410
SR6510
SR6610
SR6611
SR6710
SR6711
SR6810
SR6811







# ROULETTE INDUSTRIELLE

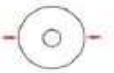

## Roue Caoutchouc Noir

Capacité de charge de 50 à 205 Kgs

Monture à oeil en tôle zinguée  
 Pivotement sur 2 couronnes de billes protégé  
 Blocage avant à double effet sur roue et pivot  
 Roue à bandage caoutchouc noir  
 Corps de roue en plastique  
 Moyeu à rouleaux  
 Axe démontable  
 Température d'utilisation de -10°C à +60°C

				
80	99	125	12	50
100	124	154	12	70
125	154	190	12	100
160	190	235	16	135
200	235		16	205

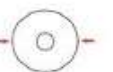
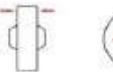
	
SOP630	SOB630
SOP640	SOB640
SOP650	SOB650
SOP660	SOB660
SOP670	SOB670

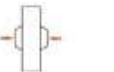
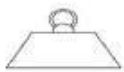
					
80	100	125	160	50	SR6301
100	30	12	40	70	SR6410
125	38	15	50	100	SR6510
160	40	20	60	135	SR6610
160	40	25	60	135	SR6611
200	50	20	60	205	SR6710
200	50	25	60	205	SR6711
250	50	20	60	250	SR6810
250	50	25	60	250	SR6811



# ROULETTE INDUSTRIELLE

## Roue Caoutchouc Gris

Capacité de charge de 50 à 295 Kgs

Monture à platine en tôle zinguée  
 Pivotement sur 2 couronnes de billes protégé  
 Blocage avant à double effet sur roue et pivot  
 Roue à bandage caoutchouc gris  
 Corps de roue en plastique  
 Moyeu à rouleaux  
 Axe démontable  
 Température d'utilisation de -10°C à +60°C



80	100	36	105x80	80x60	9	50
100	125	38	105x80	80x60	9	70
125	155	38	105x80	80x60	11	100
125	155	48	135x110	105x80	11	100
160	190	52	135x110	105x80	11	135
200	235	54	135x110	105x80	11	205
250	290	66	135x110	105x80	11	295



80	25	12	40	50
100	30	12	40	70
125	38	15	50	100
160	40	20	60	135
200	50	20	60	205
200	50	25	60	205
250	50	25	75	295



SMP730	SMF730	SMB730
SMP740	SMF740	SMB740
SMP750	SMF750	SMB750
SMP751	SMF751	SMB751
SMP761	SMF761	SMB761
SMP771	SMF771	SMB771
SMP781	SMF781	SMB781

SR7310
SR7410
SR7510
SR7610
SR7710
SR7712
SR7812



# ROULETTE INDUSTRIELLE

## Roue Caoutchouc Gris Elastic

Capacité de charge de 100 à 400 Kgs

Monture à platine en tôle zinguée  
 Pivotement sur 2 couronnes de billes protégé  
 Blocage avant à double effet sur roue et pivot  
 Roue à bandage caoutchouc gris Elastic  
 Corps de roue en plastique  
 Moyeu à rouleaux ou billes\*  
 Axe démontable  
 Température d'utilisation de -10°C à +60°C



80	108	41	105x85	80x60	9	100
100	125	38	105x80	80x60	9	140
125	155	38	105x80	80x60	11	200
125	155	48	135x110	105x80	11	250
160*	190	52	135x110	105x80	11	300
200*	235	54	135x110	105x80	11	350
250*	290	65	135x110	105x80	11	400



100	36	12	40	180
125	38	15	50	250
160	48	20	60	300
160*	48	20	60	300
200	48	20	60	400
200*	48	20	60	400
250*	50	20	60	500



SMP731	SMF731	SMB731
SMP741	SMF741	SMB741
SMP753	SMF753	SMB753
SMP752	SMF752	SMB752
SMP762	SMF762	SMB762
SMP772	SMF772	SMB772
SMP782	SMF782	SMB782

SR7413
SR7513
SR7613
SR7614
SR7713
SR7714
SR7814





# ROULETTE INDUSTRIELLE

## Roue Caoutchouc Gris Elastic

Capacité de charge de 140 à 350 Kgs

Monture à oeil en tôle zinguée  
 Pivotement sur 2 couronnes de billes protégé  
 Blocage avant à double effet sur roue et pivot  
 Roue à bandage caoutchouc gris Elastic  
 Corps de roue en plastique  
 Moyeu à rouleaux ou billes\*  
 Axe démontable  
 Température d'utilisation de -10°C à +60°C



100	124	38	12	140
125	154	38	12	150
160	190	52	16	300
160*	190	52	16	300
200	235	54	16	350
200*	235	54	16	350



100	36	12	40	180
125	38	15	50	250
160	48	20	60	300
160*	48	20	60	300
200	48	20	60	400
200*	48	20	60	400
250*	50	20	60	500



SOP741	SOB741
SOP751	SOB751
SOP761	SOB761
SOP762	SOB762
SOP771	SOB771
SOP772	SOB772

SR7413
SR7513
SR7613
SR7614
SR7713
SR7714
SR7814



# ROULETTE INDUSTRIELLE

## Roue Caoutchouc Bleu Elastic

Capacité de charge de 140 à 400 Kgs

Monture à platine en tôle zinguée  
 Pivotement sur 2 couronnes de billes protégé  
 Blocage avant à double effet sur roue et pivot  
 Roue à bandage caoutchouc bleu Elastic  
 Corps de roue en plastique  
 Moyeu à rouleaux ou billes\*  
 Axe démontable  
 Température d'utilisation de -10°C à +60°C



80	108	41	105x85	80x60	9	100
100	125	38	105x80	80x60	9	140
125	155	38	105x80	80x60	11	200
125	155	48	135x110	105x80	11	250
160	190	52	135x110	105x80	11	300
200	235	54	135x110	105x80	11	350
250*	290	66	135x110	105x80	11	400



80	34	12	40	100
100	36	12	40	180
125	38	15	50	250
125	50	20	60	250
160	48	20	60	300
160	48	25	60	350
160*	48	20	60	300
200	50	20	60	400
200*	50	20	60	400
250	50	20	60	500
250	50	25	60	500
250*	50	20	60	500



SMP931	SMF931	SMB931
SMP941	SMF941	SMB941
SMP951	SMF951	SMB951
SMP952	SMF952	SMB952
SMP961	SMF961	SMB961
SMP971	SMF971	SMB971
SMP981	SMF981	SMB981

SR9310
SR9410
SR9510
SR9511
SR9611
SR9612
SR9613
SR9710
SR9713
SR9810
SR9812
SR9813



# ROULETTE INDUSTRIELLE

## Roue Caoutchouc Bleu Elastic

Capacité de charge de 140 à 350 Kgs

Monture à oeil en tôle zinguée  
 Pivotement sur 2 couronnes de billes protégé  
 Blocage avant à double effet sur roue et pivot  
 Roue à bandage caoutchouc bleu Elastic  
 Corps de roue en plastique  
 Moyeu à rouleaux ou billes\*  
 Axe démontable  
 Température d'utilisation de -10°C à +60°C



100	124	38	12	140
-----	-----	----	----	-----

125	154	38	12	150
-----	-----	----	----	-----

160	190	52	17	300
-----	-----	----	----	-----

160*	190	52	17	300
------	-----	----	----	-----

200	235	54	17	350
-----	-----	----	----	-----

200*	235	54	17	350
------	-----	----	----	-----



80	34	12	40	100
----	----	----	----	-----

100	36	12	40	180
-----	----	----	----	-----

125	38	15	50	250
-----	----	----	----	-----

125	50	20	60	250
-----	----	----	----	-----

160	48	20	60	300
-----	----	----	----	-----

160	48	25	60	350
-----	----	----	----	-----

160*	48	20	60	300
------	----	----	----	-----

200	50	20	60	400
-----	----	----	----	-----

200*	50	20	60	400
------	----	----	----	-----

250	50	20	60	500
-----	----	----	----	-----

250	50	25	60	500
-----	----	----	----	-----

250*	50	20	60	500
------	----	----	----	-----



SOP941

SOB941

SOP951

SOB951

SOP961

SOB961

SOP962

SOB962

SOP971

SOB971

SOP972

SOB972

SR9310

SR9410

SR9510

SR9511

SR9611

SR9612

SR9613

SR9710

SR9713

SR9810

SR9812

SR9813



# ROULETTE INDUSTRIELLE

## Roue Alu-Caoutchouc Noir

Capacité de charge de 100 à 450 Kgs

Monture à platine en tôle zinguée  
 Pivotement sur 2 couronnes de billes protégé  
 Blocage avant ou arrière à double effet sur roue et pivot  
 Roue à bandage caoutchouc élastique noir  
 Corps de roue en aluminium  
 Moyeu à billes  
 Axe démontable  
 Température d'utilisation de -20°C à +60°C

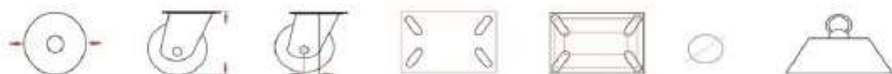

80	100	36	105x80	80x60	9	100
100	128	36	105x80	80x60	9	180
125	155	40	105x80	80x60	9	200
125	155	48	135x110	105x80	9	250
160	190	52	135x110	105x80	11	300
200	235	54	135x110	105x80	11	350
250	290	70	175x175	140x140	11	450



80	40	12	40	100
100	40	15	40	180
125	40	20	50	200
125	50	20	60	225
160	50	20	60	300
160	50	25	60	300
200	50	20	60	450
200	50	25	60	450
250	50	20	60	570
250	50	25	60	570
300	50	20	60	650



SXP130	SXF130	SXB130	SXD130
SXP140	SXF140	SXB140	SXD140
SXP150	SXF150	SXB150	SXD150
SXP153	SXF153	SXB153	SXD153
SXP163	SXF163	SXB163	SXD163
SXP173	SXF173	SXB173	SXD173
SXP183	SXF183	SXB183	SXD183

SR1420
SR1430
SR1529
SR1530
SR1630
SR1631
SR1730
SR1731
SR1830
SR1831
SR1931



# ROULETTE INDUSTRIELLE

## Roue Alu-Caoutchouc Noir

Capacité de charge de 180 à 570 Kgs

Monture à platine en tôle zinguée  
 Pivotement sur 2 couronnes de billes protégé  
 Blocage arrière à double effet sur roue et pivot  
 Roue à bandage caoutchouc élastique noir  
 Corps de roue en aluminium  
 Moyeu à billes  
 Axe démontable  
 Température d'utilisation de -20°C à +60°C

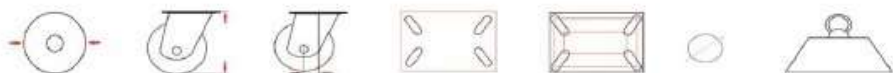

100	140	45	100x85	80x60	9	180
125	165	45	100x85	80x60	9	200
125	170	52	135x110	105x80	11	200
160	205	52	135x110	105x80	11	300
200	245	55	135x110	105x80	11	450
250	297	67	135x110	105x80	11	570



80	40	12	40	100
100	40	15	40	180
125	40	20	50	200
125	50	20	60	225
160	50	20	60	300
160	50	25	60	300
200	50	20	60	450
200	50	25	60	450
250	50	20	60	570
250	50	25	60	570
300	50	30	60	650



SXP145	SXF145	SXB145
SXP155	SXF155	SXB155
SXP152	SXF152	SXB152
SXP165	SXF165	SXB165
SXP175	SXF175	SXB175
SXP176	SXF176	SXB176

SR1420
SR1430
SR1529
SR1530
SR1630
SR1631
SR1730
SR1731
SR1830
SR1831
SR1931



# ROULETTE INDUSTRIELLE

## Roue Alu-Caoutchouc Gris

Capacité de charge de 180 à 450 Kgs

Monture à platine en tôle zinguée  
 Pivotement sur 2 couronnes de billes protégé  
 Blocage avant ou arrière à double effet sur roue et pivot  
 Roue à bandage caoutchouc élastique gris  
 Corps de roue en aluminium  
 Moyeu à billes  
 Axe démontable  
 Température d'utilisation de -20°C à +60°C



100	128	36	105x80	80x60	9	180
125	155	40	105x80	80x60	9	200
125	155	48	135x110	105x80	11	250
160	190	52	135x110	105x80	11	300
200	235	54	135x110	105x80	11	350



100	40	15	40	180
125	40	20	50	200
125	40	25	50	200
160	50	20	60	300
160	50	25	60	300
200	50	20	60	450
200	50	25	60	450
250	50	20	60	550
250	50	25	60	550



SXP142	SXF142	SXB142	SXD142
SXP151	SXF151	SXB151	SXD151
SXP154	SXF154	SXB154	SXD154
SXP162	SXF162	SXB162	SXD162
SXP172	SXF172	SXB172	SXD172

SR1431
SR1531
SR1532
SR1637
SR1638
SR1833
SR1834
SR1835
SR1836



# ROULETTE INDUSTRIELLE

## Roue Fonte-Caoutchouc CHARGE LOURDE

Capacité de charge de 350 à 1000 Kgs

Monture à platine en tôle d'acier forte épaisseur mécano-soudée  
 Pivotement sur 1 butée à billes et 1 roulement de pression  
 Roue à bandage caoutchouc élastique noir  
 Corps de roue en fonte  
 Moyeu à billes  
 Axe démontable  
 Température d'utilisation de -20°C à +60°C



200	245	55	135x110	105x80	11	350
250	314	71	175x140	140x105	13	675
300	365	83	175x140	140x105	13	750
360	420	95	175x140	140x105	13	750
400	475	111	200x160	165x125	13	1000



200	50	20	60	350
250	80	25	85	675
250	80	30	85	675
300	75	30	90	750
300	75	30	90	750
360	60	30	75	750
400	75	35	90	1000



SVP174	SVF174
SVP184	SVF184
SVP194	SVF194
SVP104	SVF104
SVP105	SVF105



SR1740
SR1845
SR1842
SR1943
SR1944
SR1946
SR1040

# ROULETTE INDUSTRIELLE

## Roue Fonte Caoutchouc Noir

Capacité de charge de 160 à 1000 Kgs

Roue à bandage caoutchouc élastique noir

Corps de roue en fonte

Bandage souple

Moyeu à billes

Température d'utilisation de -20°C à +60°C



125	50	20	60	160
125	50	20	54	225
150	50	20	60	250
160	50	20	60	300
200	50	20	60	350
250	60	25	60	525

SR1540

SR1542

SR1643

SR1640

SR1740

SR1846



Roue à bandage caoutchouc élastique noir LARGE

Corps de roue en fonte

Bandage souple

Moyeu à billes

Température d'utilisation de -20°C à +60°C



200	75	25	90	500
250	80	25	85	675
250	80	30	85	675
300	75	30	90	750
300	75	30	90	750
400	75	35	90	1000

SR1847

SR1845

SR1842

SR1943

SR1944

SR1040





# ROULETTE INDUSTRIELLE

## Roue Caoutchouc Noir

Capacité de charge de 50 à 450 Kgs

Roue à bandage caoutchouc noir

Corps de roue en tôle sertie

Bandage souple

Moyeu à rouleaux

Température d'utilisation de -20°C à +60°C

Option : Roue anti-statique



80	25	12	40	50
100	30	12	40	70
125	38	15	50	120
160	40	20	60	225
200	50	20	60	350
250	60	25	75	450

SR6312

SR6412

SR6512

SR6612

SR6712

SR6812



## Roue Polyamide

Capacité de charge de 150 à 400 Kgs

Monture à platine en tôle zinguée  
 Pivotement sur 2 couronnes de billes protégé  
 Blocage avant à double effet sur roue et pivot  
 Roue à bandage polyamide blanc  
 Moyeu à rouleaux  
 Axe démontable  
 Température d'utilisation de -20°C à +60°C  
 Option : blocage directionnel 1x360°



80	100	36	105x80	80x60	9	150
100	125	38	105x80	80x60	9	200
125	170	38	105x80	80x60	9	200
150	185	52	135x110	105x80	11	350
200	235	54	135x110	105x80	11	350
250	290	66	135x110	105x80	11	400



80	35	12	40	150
100	38	12	40	200
125	38	15	50	300
150	40	20	60	500
200	50	20	60	550
250	50	20	75	700



SMP331	SMF331	SMB331
SMP341	SMF341	SMB341
SMP351	SMF351	SMB351
SMP361	SMF361	SMB361
SMP371	SMF371	SMB371
SMP381	SMF381	SMB381

SR3311
SR3410
SR3513
SR3610
SR3710
SR3812



# ROULETTE INDUSTRIELLE

## Roue Polyamide RENFORCEE

Capacité de charge de 200 à 500 Kgs

Monture à platine en tôle zinguée  
 Pivotement sur 2 couronnes de billes  
 Blocage avant à double effet sur roue et pivot  
 Roue monobloc polyamide blanc renforcée  
 Moyeu à rouleaux  
 Axe démontable  
 Température d'utilisation de -20°C à +60°C



100	128	40	105x80	80x60	9	200
125	155	40	105x80	80x60	9	300
125	155	40	135x110	105x80	9	300
150	195	56	135x110	105x80	11	500
200	245	56	135x110	105x80	11	500



100	38	12	40	200
125	38	15	50	300
150	40	20	60	500
200	50	20	60	550



SXP341	SXF341	SXB341
SXP351	SXF351	SXB351
SXP352	SXF352	SXB352
SXP361	SXF361	SXB361
SXP371	SXF371	SXB371

SR3410
SR3513
SR3610
SR3710



## Roue Polyamide

Capacité de charge de 150 à 350 Kgs

Monture à oeil en tôle zinguée  
 Pivotement sur 2 couronnes de billes protégé  
 Blocage avant à double effet sur roue et pivot  
 Roue monobloc polyamide blanc  
 Moyeu à rouleaux  
 Axe démontable  
 Température d'utilisation de -20°C à +80°C



80	124	38	12	140
100	124	38	12	150
125	154	38	12	150
150	185	52	16	350
200	235	54	16	350



80	35	12	40	150
100	38	12	40	200
125	38	15	50	300
150	40	20	60	500
200	50	20	60	550



SOP330	SOB330
SOP340	SOB340
SOP350	SOB350
SOP360	SOB360
SOP370	SOB370



SR3311
SR3410
SR3513
SR3610
SR3710

# ROULETTE INDUSTRIELLE

## Roue Polyamide ETANCHE

Capacité de charge de 250 à 1000 Kgs

Monture à platine en tôle zinguée  
 Pivotement ETANCHE sur 2 couronnes de billes  
 Blocage avant\* ou arrière à double effet sur roue et pivot  
 Roue monobloc polyamide blanc renforcée  
 Moyeu lisse\* ou à billes  
 Axe démontable  
 Température d'utilisation de -20°C à +80°C



80*	118	40	105x80	80x60	9	250
100	128	40	105x80	80x60	9	350
125	178	50	135x110	105x80	11	600
150	210	53	135x110	105x80	11	900
200	245	55	135x110	105x80	11	1000



80*	30	12	40	250
100	35	12	40	500
125	45	15	50	600
150	50	20	60	900
150	50	25	60	900
200	50	20	60	1500
200	50	25	60	1500



SEP330	SEF330	SEB330
SEP340	SEF340	SEB340
SEP350	SEF350	SEB350
SEP360	SEF360	SEB360
SEP370	SEF370	SEB370

SR3307
SR3422
SR3515
SR3603
SR3624
SR3722
SR3723



# ROULETTE INDUSTRIELLE

## Roue Polyamide FORTE CHARGE

Capacité de charge de 500 à 1700 Kgs

Monture à platine en tôle d'acier mécano-soudée  
 Pivotement sur 2 couronnes de billes protégé  
 Blocage arrière à double effet sur roue et pivot  
 Roue monobloc polyamide blanc renforcée  
 Moyeu à billes - Axe démontable  
 Température d'utilisation de -20°C à +80°C  
**Option** : Blocage directionnel 4x90°



100	148	42	135x110	105x80	11	500
125	170	50	135x110	105x80	11	600
150	200	57	155x110	105x80	11	900
200	245	65	135x110	105x80	11	1500
250	305	80	135x110	105x80	11	1700



100	40	12	50	500
125	45	15	50	600
150	50	20	60	900
150	50	25	60	900
200	50	20	60	1500
200	50	25	60	1500
250	58	25	75	1700
250	58	30	75	1700



SVP345	SVF345	SVB345
SVP355	SVF355	SVB355
SVP365	SVF365	SVB365
SVP375	SVF375	SVB375
SVP385	SVF385	SVB385

SR3422
SR3515
SR3603
SR3624
SR3722
SR3723
SR3826
SR3824



# ROULETTE INDUSTRIELLE

## Roue Polyamide CHARGE LOURDE

Capacité de charge de 250 à 1700 Kgs

Monture à platine en tôle d'acier forte épaisseur mécano-soudée  
 Pivotement sur 1 butée à billes et 1 roulement de pression  
 Blocage arrière à double effet sur roue et pivot  
 Roue monobloc polyamide blanc renforcée  
 Moyeu lisse\* ou à billes  
 Axe démontable  
 Température d'utilisation de -20°C à +80°C



80*	130	30	135x110	105x80	11	250
100	140	30	135x110	105x80	11	500
125	170	40	135x110	105x80	11	600
150	200	46	135x110	105x80	11	900
200	245	55	135x110	105x80	11	1000
250	305	69	175x145	140x105	11	1700



80*	30	12	40	250
100	35	12	40	500
125	45	15	50	600
150	50	20	60	900
150	50	25	60	900
200	50	20	60	1500
200	50	25	60	1500
250	58	25	75	1700
250	58	30	75	1700



SVP332	SVF332	SVB332
SVP342	SVF342	SVB342
SVP352	SVF352	SVB352
SVP362	SVF362	SVB362
SVP372	SVF372	SVB372
SVP382	SVF382	SVB382

SR3307
SR3422
SR3515
SR3603
SR3624
SR3722
SR3723
SR3826
SR3824



# ROULETTE INDUSTRIELLE

## Roue Polyamide CHARGE LOURDE JUMEEE

Capacité de charge de 1200 à 3400 Kgs

Monture à platine en tôle d'acier forte épaisseur mécano-soudée

Pivotement sur 1 butée à billes et 1 roulement de pression

Roue monobloc polyamide blanc renforcée

Moyeu à billes

Axe démontable

Température d'utilisation de -20°C à +80°C

Option : blocage directionnel 4x90°



125	200	37	200x160	165x125	13	1200
150	225	42	200x160	165x125	13	1800
200	270	50	200x160	165x125	13	3000
250	365	82	270x250	220x185	17	3400



SWP350	SWF350
SWP360	SWF360
SWP370	SWF370
SWP380	SWF380



125	45	15	50	600
150	50	20	60	900
150	50	25	60	900
200	50	20	60	1500
200	50	25	60	1500
250	58	25	75	1700
250	58	30	75	1700

SR3515
SR3603
SR3624
SR3722
SR3723
SR3826
SR3824





# ROULETTE INDUSTRIELLE

## Roue Polyamide BI-COMPOSANTS

Capacité de charge de 160 à 200 Kgs

Monture à platine en tôle zinguée  
 Pivotement sur 2 couronnes de billes protégé  
 Blocage avant à double effet sur roue et pivot  
 Roue monobloc polyamide blanc avec anneau caoutchouc rouge  
 Moyeu à rouleaux  
 Axe démontable  
 Température d'utilisation de -10°C à +80°C  
**OPTION** : Roue corps blanc anneau bleu



100	128	40	105x80	80x60	9	160
125	155	38	105x80	80x60	9	200
125	155	48	135x110	105x80	11	200



100	36	8	45	160
125	38	10	45	200



SMP349	SMF349	SMB349
SMP359	SMF359	SMB359
SMP358	SMF358	SMB358



SR3420
SR3519

# ROULETTE INDUSTRIELLE

## Roue Polyuréthane 80

Capacité de charge de 75 à 300 Kgs

Monture à platine en tôle zinguée  
 Pivotement sur 2 couronnes de billes protégé  
 Blocage avant à double effet sur roue et pivot  
 Roue à bandage Polyuréthane 80 shores A  
 Corps de roue en plastique  
 Moyeu à rouleaux ou à billes\*  
 Axe démontable  
 Température d'utilisation de -10°C à +70°C

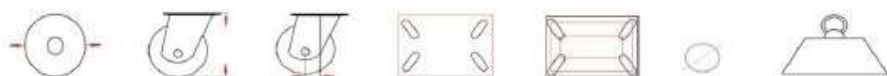

80	107	38	105x85	80x60	9	75
80*	107	38	105x85	80x60	9	85
100	128	42	105x85	80x60	9	120
100*	128	42	105x85	80x60	9	120
125	156	43	105x85	80x60	9	180
125*	156	43	105x85	80x60	9	180
150	194	56	140x110	105x80	11	250
200	240	56	140x110	105x80	11	300



80	30	12	40	75
80*	30	8	40	85
100	30	12	45	120
100*	30	8	45	130
125	35	15	45	180
125*	35	8	45	200
150	45	20	60	250
200	50	20	60	300



SMP831	SMF831	SMB831
SMP835	SMF835	SMB835
SMP841	SMF841	SMB841
SMP845	SMF845	SMB845
SMP851	SMF851	SMB851
SMP855	SMF855	SMB855
SMP861	SMF861	SMB861
SMP871	SMF871	SMB871

SR8310
SR8315
SR8410
SR8415
SR8510
SR8515
SR8610
SR8710



# ROULETTE INDUSTRIELLE

## Roue Polyuréthane 80

Capacité de charge de 75 à 300 Kgs

Monture à oeil en tôle zinguée  
 Pivotement sur 2 couronnes de billes protégé  
 Blocage avant à double effet sur roue et pivot  
 Roue à bandage Polyuréthane 80 shores A  
 Corps de roue en plastique  
 Moyeu à rouleaux  
 Axe démontable  
 Température d'utilisation de -10°C à +70°C

80	107	37	12	75
100	128	35	12	120
125	156	37	12	180
150	180	56	20	250
200	236	56	20	300

80	30	12	40	75
100	30	12	45	120
125	35	15	45	180
150	45	20	60	250
200	50	20	60	300



SOP831	SOB831
SOP841	SOB841
SOP851	SOB851
SOP861	SOB861
SOP871	SOB871

SR8310
SR8410
SR8510
SR8610
SR8710



## Roue Polyuréthane 95

Capacité de charge de 120 à 500 Kgs

Monture à platine en tôle zinguée  
 Pivotement sur 2 couronnes de billes  
 Blocage avant à double effet sur roue et pivot  
 Roue à bandage Polyuréthane 95 shores A  
 Corps de roue en plastique  
 Moyeu à rouleaux  
 Axe démontable  
 Température d'utilisation de -20°C à +80°C



80	107	38	105x85	80x60	9	120
100	128	42	105x85	80x60	9	170
125	156	43	105x85	80x60	9	220
150	194	56	140x110	105x80	11	300
200	240	56	140x110	105x80	11	300



80	30	12	40	120
100	30	12	45	170
125	35	15	45	230
150	45	20	60	350
200	50	20	60	500



SMP832	SMF832	SMB832
SMP842	SMF842	SMB842
SMP852	SMF852	SMB852
SMP862	SMF862	SMB862
SMP872	SMF872	SMB872

SR8311
SR8411
SR8511
SR8611
SR8711



# ROULETTE INDUSTRIELLE

## Roue Polyuréthane 92

Capacité de charge de 150 à 350 Kgs

Monture à platine en tôle zinguée  
 Pivotement sur 2 couronnes de billes protégé  
 Blocage avant ou arrière à double effet sur roue et pivot  
 Roue à bandage Polyuréthane 92 shores A  
 Corps de roue en aluminium  
 Moyeu à billes - Axe démontable  
 Température d'utilisation de -20°C à +80°C  
 Option : blocage directionnel 1x360°



80	100	38	105x85	80x60	9	150
100	125	38	105x80	80x60	9	200
125	155	38	105x80	80x60	9	200
160	190	52	135x110	105x80	11	350
200	235	54	135x110	105x80	11	350

SXP833	SXF833	SXB833	SXD833
SXP843	SXF843	SXB843	SXD843
SXP853	SXF853	SXB853	SXD853
SXP863	SXF863	SXB863	SXD863
SXP873	SXF873	SXB873	SXD873



82	30	12	40	180
100	40	15	40	360
125	40	20	50	450
160	50	20	60	800
160	50	25	60	800
200	50	20	60	900
200	50	25	60	900

SR8330
SR8432
SR8530
SR8631
SR8632
SR8730
SR8731



# ROULETTE INDUSTRIELLE

## Roue Polyuréthane 92 Forte Charge

Capacité de charge de 360 à 700 Kgs

Monture à platine en tôle zinguée  
 Pivotement sur 2 couronnes de billes protégé  
 Blocage arrière à double effet sur roue et pivot  
 Roue à bandage Polyuréthane 92 shores A  
 Corps de roue en aluminium  
 Moyeu à roulement à billes  
 Axe démontable  
 Température d'utilisation de -20°C à +80°C

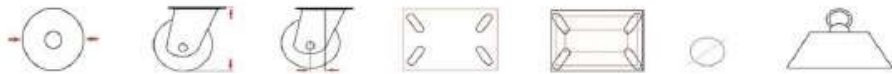

100	140	45	100x85	80x60	9	360
125	165	45	100x85	80x60	9	450
160	205	52	135x110	105x80	11	500
200	245	55	135x110	105x80	11	700



100	40	15	40	360
125	40	20	50	450
160	50	20	60	800
160	50	25	60	800
200	50	20	60	900
200	50	25	60	900



SXP943	SXF943	SXD943
SXP953	SXF953	SXD953
SXP963	SXF963	SXD963
SXP973	SXF973	SXD973

SR8432
SR8530
SR8631
SR8632
SR8730
SR8731











# ROULETTE INDUSTRIELLE

## Roue Polyuréthane 92

Capacité de charge de 150 à 350 Kgs

Monture à oeil en tôle zinguée  
 Pivotement sur 2 couronnes de billes protégé  
 Blocage avant à double effet sur roue et pivot  
 Roue à bandage Polyuréthane 92 shores A  
 Corps de roue en aluminium  
 Moyeu à roulement à billes  
 Axe démontable  
 Température d'utilisation de -20°C à +80°C

				
80	107	125	160	200
38	52	54	16	16
12	12	12	12	12
150	150	180	350	350

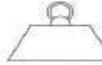
				
82	100	125	160	200
30	40	40	50	50
12	15	20	20	20
40	40	50	60	60
180	360	450	800	800
			800	900
			60	60
			25	25
			900	900



SOP833	SOB833
SOP843	SOB843
SOP853	SOB853
SOP863	SOB863
SOP873	SOB873

SR8330
SR8432
SR8530
SR8631
SR8632
SR8730
SR8731



# ROULETTE INDUSTRIELLE

## Roue Polyuréthane 92

Capacité de charge de 350 à 700 Kgs

Monture à platine en acier forte épaisseur emboutie  
 Pivotement sur 2 couronnes de billes protégé  
 Blocage arrière à double effet sur roue et pivot  
 Roue à bandage Polyuréthane 92 shores A  
 Corps de roue en fonte  
 Moyeu à billes  
 Axe démontable  
 Température d'utilisation de -20°C à +80°C



100	140	45	100x85	80x60	9	350
125	170	52	135x110	105x80	11	560
150	200	52	135x110	105x80	11	660
160	205	52	135x110	105x80	11	700
200	245	55	135x110	105x80	11	700
250	297	67	135x110	105x80	11	700



100	40	20	50	350
125	50	20	60	560
150	50	20	60	660
160	50	25	60	700
200	50	20	60	890
250	50	25	60	1100



SXP844	SXF844	SXD844
SXP854	SXF854	SXD854
SXP864	SXF864	SXD864
SXP865	SXF865	SXD865
SXP874	SXF874	SXD874
SXP884	SXF884	SXD884

SR8440
SR8551
SR8640
SR8643
SR8740
SR8841





## Roue Polyuréthane 92

Capacité de charge de 450 à 1100 Kgs

Monture à platine en acier forte épaisseur mécano-soudée

Pivotement sur rouleaux coniques

Blocage arrière à double effet sur roue et pivot

Roue à bandage Polyuréthane 92 shores A

Corps de roue en fonte

Moyeu à billes

Axe démontable

Température d'utilisation de -20°C à +80°C

Option : blocage directionnel 4x90°



100	148	42	135x110	105x80	11	450
125	170	50	135x110	105x80	11	560
150	200	57	135x110	105x80	11	660
160	205	57	135x110	105x80	11	700
200	245	65	135x110	105x80	11	1000
250	305	80	135x110	105x80	11	1100



100	40	20	50	350
125	50	20	60	560
150	50	20	60	660
160	50	25	60	700
200	50	20	60	890
250	50	25	60	1100



SVP844	SVF844	SVD844
SVP854	SVF854	SVD854
SVP864	SVF864	SVD864
SVP865	SVF865	SVD865
SVP874	SVF874	SVB874
SVP884	SVF884	SVB884

SR8440
SR8541
SR8640
SR8643
SR8740
SR8841



# ROULETTE INDUSTRIELLE

## Roue Polyuréthane 92 Large

Capacité de charge de 800 à 4000 Kgs

Monture à platine en acier forte épaisseur mécano-soudée

Pivotement sur rouleaux coniques

Blocage arrière à double effet sur roue et pivot

Roue à bandage Polyuréthane 92 shores A

Corps de roue en fonte

Moyeu à billes

Axe démontable

Température d'utilisation de -20°C à +80°C

Option : blocage directionnel 4x90°



150	217	49	175x140	140x105	13	800
200	264	60	175x140	140x105	13	1350
250	314	71	175x140	140x105	13	1700
300	365	83	175x140	140x105	13	2000
400	510	114	270x250	230x210	17	4000



SVP863	SVF863	SVD863
SVP875	SVF875	SVD875
SVP889	SVF889	SVD889
SVP894	SVF894	SVD894
SVP896	SVF896	SVD896



150	60	20	60	800
200	75	25	75	1350
250	75	30	75	1650
300	75	30	85	2000
400	100	40	120	3100

SR8640
SR8748
SR8850
SR8951
SR8040



# ROULETTE INDUSTRIELLE

## Roue Polyuréthane 92 Jumelée

Capacité de charge de 900 à 4400 Kgs

Monture à platine en acier forte épaisseur mécano-soudée

Pivotement sur rouleaux coniques

Roue à bandage Polyuréthane 95 shores A

Corps de roue en fonte

Moyeu à billes - Axe démontable

Température d'utilisation de -20°C à +80°C

Option : blocage directionnel 4x90°



100	175	33	200x160	165x125	13	900
-----	-----	----	---------	---------	----	-----

125	200	37	200x160	165x125	13	1100
-----	-----	----	---------	---------	----	------

150	225	42	200x160	165x125	13	1300
-----	-----	----	---------	---------	----	------

200	270	50	200x160	165x125	13	2000
-----	-----	----	---------	---------	----	------

250	325	62	200x160	165x125	13	2200
-----	-----	----	---------	---------	----	------

250	365	82	270x250	220x185	17	3400
-----	-----	----	---------	---------	----	------

300	415	93	270x250	220x185	17	4000
-----	-----	----	---------	---------	----	------

360	470	105	270x250	220x185	17	4400
-----	-----	-----	---------	---------	----	------



100	50	20	60	450
-----	----	----	----	-----

125	50	20	60	560
-----	----	----	----	-----

150	50	20	60	660
-----	----	----	----	-----

200	50	20	60	890
-----	----	----	----	-----

250	50	25	60	1050
-----	----	----	----	------

250	75	30	75	1650
-----	----	----	----	------

300	75	30	85	2000
-----	----	----	----	------

360	75	40	90	2200
-----	----	----	----	------



SWP844	SWF844
--------	--------

SWP854	SWF854
--------	--------

SWP864	SWF864
--------	--------

SWP874	SWF874
--------	--------

SWP884	SWF884
--------	--------

SWP885	SWF885
--------	--------

SWP895	SWF895
--------	--------

SWP896	SWF896
--------	--------

SR8448
--------

SR8541
--------

SR8640
--------

SR8740
--------

SR8841
--------

SR8850
--------

SR8951
--------

SR8952
--------



# ROULETTE INDUSTRIELLE

## Roue Polyuréthane 95

Capacité de charge de 40 à 70 Kgs

Monture à platine ou à oeil en tôle zinguée  
 Pivotement sur 2 couronnes de billes protégé  
 Blocage avant à double effet sur roue et pivot  
 Roue à bandage Polyuréthane 95 shores A  
 Corps de roue en plastique  
 Moyeu lisse  
 Axe démontable  
 Température d'utilisation de -5°C à +40°C



40	59	23	42x42	32x32	5	40
----	----	----	-------	-------	---	----

50	66	24	55x55	40x40	6	55
----	----	----	-------	-------	---	----

60	83	21	60x60	45x45	6	70
----	----	----	-------	-------	---	----



40	59	23	10	40
----	----	----	----	----

50	66	24	10	55
----	----	----	----	----

60	83	21	13	70
----	----	----	----	----



40	18	8	21	40
----	----	---	----	----

50	18	8	22	55
----	----	---	----	----

60	25	8	28	70
----	----	---	----	----



SMP802

SMF802

SMB802

SMP812

SMF812

SMB812

SMP822

SMF822

SMB822



SOP802

SOB802

SOP812

SOB812

SOP822

SOB822

SR8010

SR8020

SR8030



# ROULETTE INDUSTRIELLE

## Roue Polyuréthane 92 Surbaissée

Capacité de charge de 100 à 700 Kgs

Monture à platine ou à oeil en tôle zinguée ou mécano-soudée\*

Pivotement sur 2 couronnes de billes

Blocage avant à double effet sur roue et pivot

Roue à bandage Polyuréthane 92 shores A

Corps de roue en acier

Moyeu à billes

Axe démontable

Température d'utilisation de -10°C à +60°C



35	66	15	60x48	48x35	6	100
----	----	----	-------	-------	---	-----

50	71	25	60x60	45x45	6	150
----	----	----	-------	-------	---	-----

82*	131	55	135x110	105x80	12	700
-----	-----	----	---------	--------	----	-----



35	58	15	10	100
----	----	----	----	-----

50	71	25	10	150
----	----	----	----	-----



35	27	8	27	100
----	----	---	----	-----

50	40	8	45	150
----	----	---	----	-----



SVP801

-

SVP802

SVB802

-

-

SVP835

SVF835



SVP800

-

SVP803

SVB803



SR8110

SR8210

## Roue Polyamide Blanc

Capacité de charge de 180 à 300 Kgs



Monture à platine en tôle d'acier Inox 304  
 Pivotement sur 2 couronnes de billes Inox protégé  
 Blocage avant à double effet sur roue et pivot  
 Roue monobloc polyamide 6 blanc  
 Moyeu lisse  
 Axe démontable  
 Température d'utilisation de -30°C à +70°C

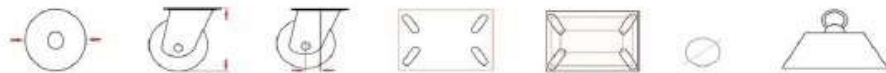

80	107	39	100x85	80x60	9	180
100	128	35	100x85	80x60	9	200
125	156	37	100x85	80x60	9	220
150	194	56	140x110	105x80	11	300
200	240	56	140x110	105x80	11	300



80	30	12	34	180
100	30	12	45	200
125	35	15	45	220
150	45	20	60	300
200	50	20	60	300



SIP331	SIF331	SIB331
SIP341	SIF341	SIB341
SIP351	SIF351	SIB351
SIP361	SIF361	SIB361
SIP371	SIF371	SIB871





SR3301
SR3401
SR3500
SR3600
SR3700







## Roue Polyamide Blanc

Capacité de charge de 55 à 300 Kgs

Monture à oeil en tôle d'acier Inox 304  
 Pivotement sur 2 couronnes de billes Inox protégé  
 Blocage avant à double effet sur roue et pivot  
 Roue monobloc polyamide 6 blanc  
 Moyeu lisse  
 Axe démontable  
 Température d'utilisation de -30°C à +70°C

				
50	70	26	12	55
60	90	26	12	60
80	107	39	12	180
100	128	35	12	200
125	156	37	12	220
150	188	56	20	300
200	236	56	20	300

				
80	30	12	40	180
100	30	12	45	200
125	35	15	45	220
150	45	20	60	300
200	50	20	60	300



SJP310	SJB310
SJP320	SJB320
SJP331	SJB331
SJP341	SJB341
SJP351	SJB351
SJP361	SJB361
SJP371	SJB371

SR3301
SR3401
SR3500
SR3600
SR3700



## Roue Caoutchouc Bleu

Capacité de charge de 120 à 300 Kgs

Monture à platine en tôle d'acier Inox 304  
 Pivotement sur 2 couronnes de billes Inox protégé  
 Blocage avant à double effet sur roue et pivot  
 Roue à bandage caoutchouc bleu  
 Moyeu à rouleaux inox  
 Corps de roue en plastique  
 Axe démontable  
 Température d'utilisation de -10°C à +70°C



80	108	28	95x80	80x60	9	120
100	127	32	95x80	80x60	9	140
125	155	45	100x80	80x60	9	180
160	195	55	135x110	105x80	11	250
200	235	55	135x110	105x80	11	300



80	30	12	40	120
100	30	12	40	140
125	38	15	45	180
160	48	20	60	250
200	50	20	60	350



SIP930	SIF930	SIB930
SIP940	SIF940	SIB940
SIP950	SIF950	SIB950
SIP960	SIF960	SIB960
SIP970	SIF970	SIB970

SR9312
SR9412
SR9512
SR9612
SR9712





## Roue Caoutchouc Bleu

Capacité de charge de 120 à 300 Kgs



Monture à oeil en tôle d'acier Inox 304  
 Pivotement sur 2 couronnes de billes Inox protégé  
 Blocage avant à double effet sur roue et pivot  
 Roue à bandage caoutchouc bleu  
 Corps de roue en plastique  
 Moyeu à rouleaux Inox  
 Axe démontable  
 Température d'utilisation de -10°C à +70°C



80	107	38	9	120
----	-----	----	---	-----

100	127	32	12	140
-----	-----	----	----	-----

125	155	32	12	150
-----	-----	----	----	-----

160	192	56	20	250
-----	-----	----	----	-----

200	240	56	20	300
-----	-----	----	----	-----



80	30	12	40	120
----	----	----	----	-----

100	30	12	45	120
-----	----	----	----	-----

125	35	15	45	180
-----	----	----	----	-----

160	48	20	60	250
-----	----	----	----	-----

200	50	20	60	300
-----	----	----	----	-----



SJP930

SJB930

SJP940

SJB940

SJP950

SJB950

SJP960

SJB960

SJP970

SJB970

SR9312

SR9412

SR9512

SR9611

SR9712



## Roue Polyuréthane 80

Capacité de charge de 75 à 300 Kgs

Monture à platine en tôle d'acier Inox 304  
 Pivotement sur 2 couronnes de billes Inox protégé  
 Blocage avant à double effet sur roue et pivot  
 Roue à bandage Polyuréthane 80 shores A  
 Corps de roue en plastique  
 Moyeu à rouleaux Inox  
 Axe démontable  
 Température d'utilisation de -10°C à +70°C



80	107	38	105x85	80x60	9	75
100	128	42	105x85	80x60	9	120
125	156	43	105x85	80x60	9	180
150	193	56	135x110	105x80	11	250
200	237	56	135x110	105x80	11	300



80	30	12	40	75
100	30	12	45	120
125	35	15	45	180
150	45	20	60	250
200	50	20	60	300



SIP837	SIF837	SIB837
SIP847	SIF847	SIB847
SIP857	SIF857	SIB857
SIP867	SIF867	SIB867
SIP877	SIF877	SIB877

SR8370
SR8470
SR8570
SR8670
SR8770



## Roue Polyuréthane 80

Capacité de charge de 75 à 300 Kgs

Monture à oeil en tôle d'acier Inox 304  
 Pivotement sur 2 couronnes de billes Inox protégé  
 Blocage avant à double effet sur roue et pivot  
 Roue Polyuréthane 80 shore A  
 Corps de roue en plastique  
 Moyeu à rouleaux Inox  
 Axe démontable  
 Température d'utilisation de -10°C à +70°C



80	107	39	12	75
100	128	35	12	120
125	156	37	12	180
150	188	56	20	250
200	240	56	20	300



80	30	12	39	75
100	30	12	44	120
125	35	15	44	180
150	45	20	60	250
200	50	20	60	300



SJP837	SJB837
SJP847	SJB847
SJP857	SJB857
SJP867	SJB867
SJP877	SJB877







SR8370
SR8470
SR8570
SR8670
SR8770









## Roue Hautes Températures

Capacité de charge de 100 à 200 Kgs







Monture à platine en tôle zinguée  
 Pivotement sur 1 couronne de billes à boîtier étanche  
 Roue en floconage compressé  
 Moyeu à billes  
 Axe démontable  
 Température d'utilisation de -40°C à +300°C

						
70	104	40	105x80	80x60	9	200
100	130	40	105x80	80x60	9	200

Monture à platine en tôle zinguée  
 Pivotement sur 2 couronnes de billes  
 Roue à bandage caoutchouc\* ou résine phénolique  
 Moyeu lisse  
 Axe démontable  
 Température d'utilisation :  
 De 0°C à +250°C (Cycle de 30min) pour la roue caoutchouc  
 De -40°C à +300°C pour la roue phénolique

						
80	100	36	105x80	80x60	9	120
100*	130	34	105x80	80x60	9	100
100	132	34	105x80	80x60	9	150

Monture à platine en tôle zinguée  
 Pivotement sur 2 couronnes de billes ou boîtier étanche\*  
 Roue à bandage silicone - Corps aluminium  
 Moyeu à billes  
 Axe démontable  
 Température d'utilisation de -40°C à +250°C

						
100	128	32	105x80	80x60	9	80
100*	128	45	105x80	80x60	9	80



SEP032	SEF032
SEP042	SEF042



SMP031	SMF031
SMP040	SMF040
SMP041	SMF041



SMP045	SMF045
SEP045	SEF045

## Roue Hautes Températures

Capacité de charge de 100 à 200 Kgs



Monture à platine en tôle d'acier Inox 304  
 Pivotement sur 2 couronnes de billes Inox  
 Roue résine phénolique renforcée  
 Moyeu à billes  
 Axe démontable  
 Température d'utilisation de -40°C à +300°C

80	108	40	105x80	80x60	9	125
100	130	40	105x80	80x60	9	200

Monture à platine en tôle d'acier Inox 304  
 Pivotement sur 2 couronnes de billes Inox  
 Roue à bandage caoutchouc\* ou résine phénolique  
 Moyeu lisse  
 Axe démontable  
 Température d'utilisation :  
 De 0°C à +250°C (Cycle de 30min) pour la roue caoutchouc  
 De -40°C à +300°C pour la roue phénolique

100*	130	34	105x80	80x60	9	100
80	132	38	105x80	80x60	9	150
100	132	42	105x80	80x60	9	150

Monture à platine en tôle d'acier Inox 304  
 Pivotement sur 2 couronnes de billes Inox  
 Roue à bandage silicone - Corps aluminium  
 Moyeu à billes  
 Axe démontable  
 Température d'utilisation de -40°C à +250°C

100	128	37	105x80	80x60	9	80



SIP034	SIF034
SIP043	SIF043



SIP040	SIF040
SIP033	SIF033
SIP041	SIF041



SIP045	SIF045
--------	--------

# ROUE INDUSTRIELLE

## Roue Hautes Températures

Capacité de charge de 100 à 200 Kgs

Roue spéciale chariot de boulangerie  
 Roue à bandage caoutchouc de 0°C à +250 °C (cycle de 30mm)  
 Roue en résine phénolique\* de -30°C à +300°C  
 Roue en résine phénolique\*\* de -30°C à +300°C  
 Roue à bandage silicone\* de -40°C à +250°C  
 Moyeu lisse ou à billes



100	40	12 LISSE	40	100
70*	35	8 BILLES	40	200
80**	35	12 LISSE	40	100
100**	40	12 LISSE	45	200
100*	40	8 BILLES	45	200
100*	40	15 BILLES	40	100

Roue spéciale fumoir, étuve, four autoclave  
 Roue en polyamide chargé fibre de verre de -30°C à +180°C  
 Moyeu lisse  
 Couleur noir, blanc sur demande



100	30	12	40	150
125	40	12	45	200
150	40	20	50	300
200	50	20	60	400



SR0409	-	-	-
-	SR0325	-	-
-	-	SR0305	-
-	-	SR0306	-
-	SR0425	-	-
-	-	-	SR0415

SR0404  
 SR0504  
 SR0605  
 SR0705



## Roue Fonte

Capacité de charge de 250 à 1000 Kgs

Monture à platine en tôle zinguée  
 Pivotement sur 2 couronnes de billes  
 Roue fonte mécanique usinée  
 Moyeu à rouleaux ou à billes\*  
 Axe démontable  
 Température d'utilisation de -30°C à +120°C



80	128	42	105x85	80x60	9	250
100	138	42	105x85	80x60	9	450
100*	138	42	105x85	80x60	9	450
125	164	42	135x110	105x80	11	500
125*	295	42	135x110	105x80	11	500
150	203	63	135x110	105x80	11	750
150*	203	63	135x110	105x80	11	750
200	250	63	135x110	105x80	11	1000
200*	250	63	135x110	105x80	11	1000



80	30	12	40	250
100	30	15	40	400
100*	30	15	40	500
125	35	12	45	400
125*	50	20	60	600
150	50	20	60	800
150*	50	20	60	1200
200	50	20	60	1000
200*	50	20	60	1500



SFP030	SFF030
SFP040	SFF040
SFP041	SFF041
SFP050	SFF050
SFP051	SFF051
SFP060	SFF060
SFP061	SFF061
SFP070	SFF070
SFP071	SFF071

SR0430
SR0441
SR0442
SR0450
SR0451
SR0462
SR0463
SR0467
SR0470



# ROULETTE INDUSTRIELLE

## Roue Pneumatique

Capacité de charge de 75 à 200 Kgs

Monture à platine en tôle zinguée  
 Pivotement sur 2 couronnes de billes  
 Roue à bandage caoutchouc noir gonflable sauf GP481 increvable  
 Corps de roue en plastique ou tôle\*  
 Moyeu à rouleaux ou à billes\* - Axe démontable  
 Température d'utilisation de -10°C à +60°C  
**OPTION** : Frein sur demande



200*	235	54	135x110	105x80	11	75
260	295	70	175x175	140x140	11	200
260**	295	70	175x175	140x140	11	200
260	295	70	175x175	140x140	11	100

Chambre à air pour roue diam 200  
 Référence : SR4012CH

Chambre à air pour roue diam 260  
 Référence : SR4700CH



SGP470	SGF470	-	-
-	-	SGP480	SGF480
SGP482	SGF482	-	-
-	-	SGP481	SGF481



# ROUE INDUSTRIELLE

## Roue Pneumatique Gonflable

Capacité de charge de 70 à 1200 Kgs

Roue à bandage pneumatique gonflable  
 Bandage caoutchouc noir sauf R4710 caoutchouc gris  
 Corps de roue en plastique ou en tôle\*  
 Moyeu lisse, à rouleaux ou à billes  
 Température d'utilisation de -10°C à +60°C



200	50	20 ROULEAUX	60	70
200*	50	20 ROULEAUX	60	70
260	85	20 LISSE	74	150
260	85	20 ROULEAUX	74	150
260	85	25 LISSE	74	150
260	85	25 ROULEAUX	74	150
260*	85	20 ROULEAUX	74	150
260*	85	20 BILLES	74	150
312*	116	20 BILLES	75	350
400	85	20 ROULEAUX	74	200
400*	100	25 ROULEAUX	74	200
400*	100	25 BILLES	74	200
414*	120	30 BILLES	100	780
476*	143	30 BILLES	100	1200

- SR4710
- SR4711
- SR4800
- SR4810
- SR4801
- SR4811
- SR4812
- SR4820
- SR4922
- SR4010
- SR4012
- SR4024
- SR4022
- SR4023



# ROUE INDUSTRIELLE

## Roue Pneumatique Incevable

Capacité de charge de 70 à 1415 Kgs

Roue à bandage pneumatique increvable

Bandage caoutchouc noir

Corps de roue en plastique

Moyeu lisse, à rouleaux

Température d'utilisation de -10°C à +60°C



260	85	20 LISSE	74	70
260	85	25 LISSE	74	70
260	85	20 ROULEAUX	74	70
260	85	25 ROULEAUX	74	70
400	85	20 LISSE	74	150
400	85	25 LISSE	74	150
400	85	20 ROULEAUX	74	150
400	85	25 ROULEAUX	74	150

SR4808

SR4809

SR4818

SR4819

SR4816

SR4817

SR4829

SR4827



Roue à bandage pneumatique increvable

Bandage caoutchouc noir

Corps de roue en tôle boulonné

Moyeu à billes

Température d'utilisation de -10°C à +60°C



260	85	20 BILLES	74	260
414	120	25 BILLES	100	950
476	143	30 BILLES	100	1415

SR4825

SR4025

SR4027



## EMBOUTS PLASTIQUE

### Embout Ronds Carrés Rectangulaires

Embout en plastique noir  
 Epaisseur de la semelle 3 à 5 mm  
 Les dimensions des tubes sont EXTERIEURES  
 Nombreux modèles - Consultez-nous

#### SERIE 44



10 mm	20 mm	40 mm	70 mm
12 mm	22 mm	42 mm	76 mm
13 mm	25 mm	45 mm	80 mm
14 mm	28 mm	48 mm	88 mm
15 mm	30 mm	50 mm	90 mm
16 mm	32 mm	55 mm	102 mm
18 mm	35 mm	60 mm	114 mm

#### SERIE 41



12x12 mm	25x25 mm	60x60 mm
14x14 mm	30x30 mm	70x70 mm
16x16 mm	35x35 mm	80x80 mm
18x18 mm	40x40 mm	90x90 mm
20x20 mm	45x45 mm	100x100 mm
25x25 mm	50x50 mm	120x120 mm

#### SERIE 43



10x20 mm	40x27 mm	60x30 mm	100x50 mm
30x10 mm	40x30 mm	60x40 mm	120x40 mm
30x15 mm	50x20 mm	80x40 mm	120x60 mm
30x20 mm	50x25 mm	80x50 mm	120x80 mm
35x15 mm	50x30 mm	10x25 mm	140x80 mm
40x20 mm	50x40 mm	100x40 mm	150x50 mm

## EMBOUTS CAOUTCHOUC - VERINS

### Embout Ronds Carrés Taraudés Verin

Embout en caoutchouc noir sauf vérin et embout taraudé  
 Taraudage M10  
 Les dimensions des tubes sont EXTERIEURES  
 Nombreux modèles - Consultez-nous

#### SERIE 48



10 mm	18 mm	28 mm
12 mm	20 mm	30 mm
14 mm	22 mm	32 mm
16 mm	25 mm	34 mm

#### SERIE 40



20 mm	30 mm	40 mm
25 mm	32 mm	45 mm
28 mm	35 mm	50 mm

#### SERIE 40



20x20 mm	35x35 mm
25x25 mm	40x40 mm
30x30 mm	50x50 mm



Patin diam 30 mm	LG 50 mm	M10 mm
Patin diam 40 mm	LG 45 mm	M10 mm
Patin diam 50 mm	LG 50 mm	M10 mm

# ROUE INDUSTRIELLE

## Roue Wagonnet

Capacité de charge de 250 à 1650 Kgs

Roue monobloc en fonte mécanique usinée  
 Très faible effort de démarrage et de roulement  
 Utilisation sur rails ou profils rectangulaires  
 Moyeu à billes  
 Température d'utilisation de -30°C à +120°C

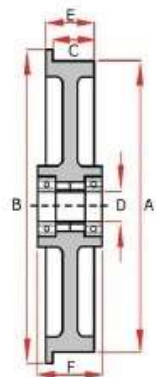

A	B	C	D	E	F		Référence
100	120	20	20	44	46	250	SR0448
105	125	15	20	27	27	250	SR0449
125	145	40	20	50	60	500	SR0451
130	150	35	20	45	45	500	SR0459
150	170	40	20	50	50	750	SR0469
200	227	40	20	50	50	1200	SR0479
250	286	45	25	60	60	1400	SR0489
300	330	45	30	60	60	1650	SR0499





# ROULETTE POUR THEATRE - OPERA

## Roue Alu-Caoutchouc ou Alu-Polyuréthane

Capacité de charge de 350 kgs

Tripode à pivot central  
 Tête de pivotement montée sur roulement à billes  
 Roue à bandage caoutchouc ou polyuréthane  
 Corps de roue en aluminium  
 Moyeu à billes



				Référence Polyuréthane	Référence Caoutchouc
100	135X110	105x80	360	scenik01	scenik03

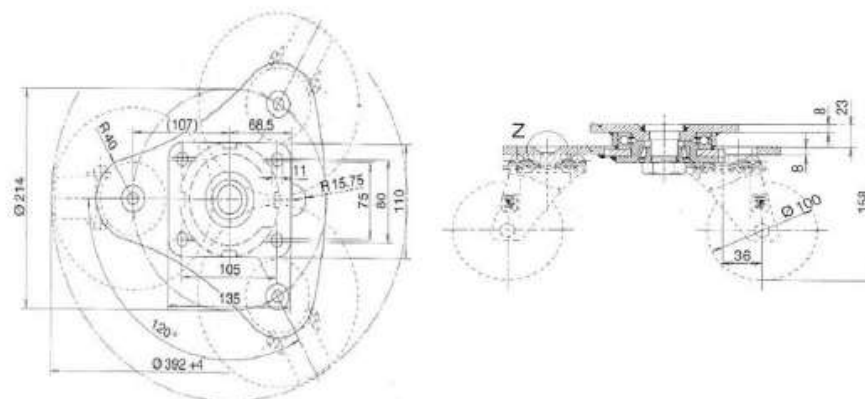

# MANUTENTION

## ■ Patin d'immobilisation

Fabrication en acier forte épaisseur  
 Patin en caoutchouc anti-dérapant  
 Utilisé pour immobiliser et non pour lever

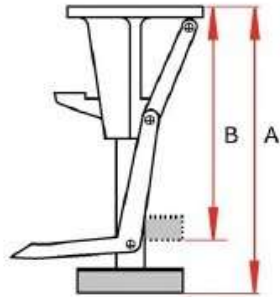

			A	B	Référence
			200	164	SPATIN01
152X115	127x64	14			

# MANUTENTION

## ■ Couronnes à billes - Rond d'avant train

Capacité de charge de 500 à 4000 Kgs

Couronne en acier  
 Moyeu à billes  
 Vitesse maximum d'utilisation 30KM/H  
 Fourni sans trous de fixation

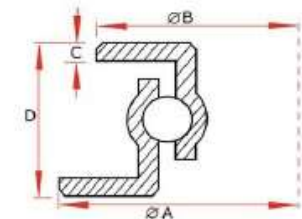

A	B	C	D		Référence
300	293	5	55	500	SCOUR03
400	400	5	55	750	SCOUR04
500	500	5	55	1000	SCOUR05
600	600	8	65	1700	SCOUR06
700	700	8	65	2200	SCOUR07
800	800	8	65	2500	SCOUR08
900	900	8	65	3500	SCOUR09
1000	1000	8	65	4000	SCOUR10

## Roulements à billes

Roulements à billes standard

Corps en acier

Z : Protection métallique 1 côté

ZZ : Protection métallique 2 côtés

1RS : Etanchéité plastique 1 côté

2RS : Etanchéité plastique 2 côtés

ZV : Bague déportée

ZZV : Bague déportée et protection métallique

**OPTION** : Inox sur demande

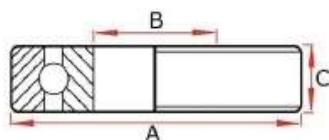

Type	A	B	C	Référence
------	---	---	---	-----------

6204 2RS	47	20	14	SROUL01
6303 Z	47	17	14	SROUL02
6204 ZV	47	20	12	SROUL03
6303 ZZV	47	17	14	SROUL04
6004 2RS	42	20	12	SROUL05
6005 ZZ	47	25	12	SROUL06
6002 ZZ	32	15	9	SROUL07
6003 2RS	35	17	10	SROUL08
6201 ZZ	32	12	10	SROUL09
6201 2RS	32	12	10	SROUL10
6000 2RS	26	10	8	SROUL11
6202 ZZ	35	15	11	SROUL12
6205 2RS	52	25	15	SROUL13
6007 2RS	62	55	14	SROUL14

## Tournette - Double platine rotative

Capacité de charge de 100 à 2000 Kgs

Double platine en tôle d'acier

1 Pivotement sur une couronne de billes

2 Pivotement sur roulement à billes

3 Pivotement sur roulement à billes et un roulement de pression

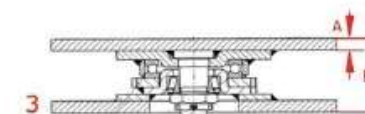
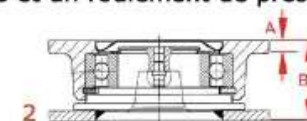

A

B

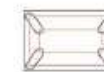

Référence

1	2	17	100x80	85x60	8	100	SPLAT01
1	2.5	22	140x110	105x80	8	150	SPLAT02
1	3	23	135x110	105x80	11	350	SPLAT03
2	8	47	135x110	105x80	11	1000	SPLAT04
3	10	65	250x130	200x105	11	2000	SPLAT05

## TRANSPALETTE MANUEL

### Jungheinrich/Mic - Galet Roue Directrice



					Matière Corps / Bandage	Référence FABRICANT	Référence SEPT
82	70	-	70	Acier / Tophane	50162500 36853000 71307320 26008000 70206760 036853 26008	WG88082	
82	100	-	100	Acier / Tophane	50162000 36852000 71305290 50025048	WG88001	
82	70	20	72	Acier / Tophane	00632886 40318007	WG88080	
82	98	20	98	Acier / Tophane	90153011 50052962	WG88075	



200	50	-	60	Alu / Caoutchouc	43613000 71806260 0780688	WD87017
175	57	20	60	Alu / Caoutchouc	090188000 50052941	WD87003
200	50	20	60	Alu / Caoutchouc	0038637511F	WD87012

## TRANSPALETTE ELECTRIQUE

### Mic - Galet Roue Stabilisatrice Roue Motrice



					Matière Corps / Bandage	Référence FABRICANT	Référence SEPT
82	70	-	70	Acier / Tophane	04318107	WG88082	
82	100	-	100	Acier / Tophane	36852	WG88001	
82	90	-	90	Acier / Vulkollan	059725000	WG88123	



100	40	-	40	Fonte / Vulkollan	06505800001	WS86019
110	50	-	50	Fonte / Tophane	054210000	WS86003SR
120	50	-	50	Fonte / Vulkollan	0542110120B	WS86011SR



Roue motrice Fonte / Tophane 230/85 - 4 Trous	058259001	WM85024
Roue motrice Fonte / Caoutchouc 230/85 - 4 Trous	058259000	WM85014
Roue motrice Fonte / Vulkollan 250/90 - 4 Trous	060286002	WM85008
Roue motrice Fonte / Caoutchouc 250/90 - 4 Trous	060286003	WM85088
Roue motrice Fonte / Vulkollan 230/85 - 5 Trous	065698005	WM85006
Roue motrice Fonte / Caoutchouc 230/85 - 5 Trous	065698003	WM85089
Roue motrice Fonte / Vulkollan 230/85 - 5 Trous	4105062069	WM85022

## TRANSPALETTE ELECTRIQUE

### Fenwick - Galet Roue Stabilisatrice



					Matière Corps / Bandage	Référence FABRICANT	Référence SEPT
85	60	12	60	60	Acier / Vulkollan	0039903512	WG88051
85	60	20	65	65	Acier / Vulkollan	0039903500	WG88003
85	80	12	85	85	Acier / Vulkollan	0039933603	WG88067
85	105	12	85	85	Acier / Vulkollan	0039933604	WG88063
82	60	20	60	60	Acier / Tophane	0039903513	WG88010
85	70	20	70	70	Acier / Tophane	1415501103	WG88090
82	66	20	71	71	Acier / Tophane	8104111 1415501103	WG88004



100	40	15	40	40	Fonte / Tophane	0009933808	WS86015
125	40	20	60	60	Alu / Caoutchouc	00039903508	WS86078
125	40	20	54	54	Fonte / Vulkollan	0039903509	WS86012
150	40	12	48	48	Fonte / Vulkollan	0039903515	WS86047
180	65	25	75	75	Fonte / Vulkollan	003993802	WS86079
100	40	15	40	40	Alu / Tophane	0009933800	WS86010

## TRANSPALETTE ELECTRIQUE

### Fenwick - Roue Motrice Roue Porteuse Rétrac



	Matière Corps / Bandage	Référence FABRICANT	Référence SEPT
Roue motrice Fonte / Vulkollan 230/90 - 4 Trous		0039902305	WM85057
Roue motrice Fonte / Caoutchouc 230/90 - 4 Trous		0039902310	WM85086
Roue motrice Fonte / Caoutchouc 230/90 - 6 Trous		5803581	WM85032
Roue motrice Fonte / Caoutchouc 254/102 - 5 Trous		0039902308	WM85058
Roue motrice Fonte / Vulkollan 254/102 - 5 Trous		0039902311	WM85059
Roue motrice Fonte / Vulkollan 230/90 - 6 Trous		0039902320	WM85074



Porteuse 285/100 frein tambour Fonte / Vulkollan	3769901500	WP89012
Porteuse 285/100 Fonte / Vulkollan	0039937041	WP89002



## TRANSPALETTE ELECTRIQUE

### Jungheinrich - Galet Roue Stabilisatrice



					Matière Corps / Bandage	Référence FABRICANT	Référence SEPT
85	60	25	65	Acier / Vulkollan	27631400	WG88048	
85	75	25	80	Acier / Vulkollan	27631320	WG88076	
85	80	25	80	Acier / Vulkollan	27631380	WG88122	
85	100	25	105	Acier / Vulkollan	27631330	WG88088	
85	110	25	110	Acier / Vulkollan	07631340	WG88044	
85	80	20	85	Acier / Vulkollan	50015001	WG88055	
85	85	25	90	Acier / Vulkollan	50010588	WG88014	
85	95	25	100	Acier / Vulkollan	27631390	WG88052	
82	70	20	70	Acier / Tophane	7137320	WG88121	
82	100	20	100	Acier / Tophane	71305290	WG88124	



100	40	15	40	Alu / Tophane	27634540 50303847	WS86010
110	40	-	50	Fonte / Tophane	71312090	WS86003SR
180	65	25	75	Fonte / Vulkollan	27637400	WS86021
140	54	20	60	Alu / Tophane	5001977 50432647	WS86030
150	54	20	60	Fonte / Tophane	27634500	WS86039
180	50	25	60	Fonte / Vulkollan	27626480	WS86023
100	40	15	40	Fonte / Tophane	16008970	WS86022

## TRANSPALETTE ELECTRIQUE

### Jungheinrich - Stabilisateur Motrice Porteuse



	Matière Corps / Bandage	Référence FABRICANT	Référence SEPT
Stab complet diam 100 HT 156	Alu / Tophane	50029851	WS86080
Stab complet diam 100 HT 156	Fonte / Tophane	50002508 50028712	WS86081



Roue motrice Fonte / Tophane 200/85 - 4 Trous	61354080	WM85009
Roue motrice Fonte / Vulkollan 230/85 - 5 Trous	63215600	WM85022
Roue motrice Fonte / Tophane 230/82 - 5 Trous	6315600	WM85003
Roue motrice Fonte / Vulkollan 230/70 - 5 Trous	63210590 50020215	WM85023



Porteuse diam 285/100 lm 104	Fonte / Vulkollan	63131380	WP89008
Porteuse diam 200/82 lm 82	Fonte / Tophane	27630260	WP89004
Porteuse diam 200/100	Fonte / Vulkollan	63187810	WP89001
Porteuse diam 285/100 lm 62	Fonte / Vulkollan	63195320 50015372	WP89009

## TRANSPALETTE ELECTRIQUE

### Still - Galet Roue Stabilisatrice



				Matière Corps / Bandage	Référence FABRICANT	Référence SEPT
85	80	17	82	Acier / Vulkollan	8411624 4411624	WG88007
85	80	20	85	Acier / Vulkollan	8665538	WG88055
85	86	17	88	Acier / Vulkollan	8190121	WG88029
85	59	17	61	Acier / Vulkollan	8190118	WG88017
85	100	17	102	Acier / Vulkollan	8098331	WG88012
85	100	25	105	Acier / Vulkollan	8413923	WG88006
85	105	25	110	Acier / Vulkollan	5405886	WG88126
85	100	25	102	Acier / Tophane	14490050 4490050	WG88033
82	66	20	71	Acier / Vulkollan	660128 660132	WG88004



100	40	15	40	Alu / Tophane	27634540 50303847	WS86010
100	40	15	40	Fonte / Tophane	9933808	WS86015
180	65	25	75	Fonte / Vulkollan	5444816	WS86028
150	60	20	60	Fonte / Tophane	1412343 4414979	WS86020
100	40	15	40	Fonte / Tophane	8413462 8668960	WS86028

## TRANSPALETTE ELECTRIQUE

### Still - Stabilisateur complet Roue Motrice



	Matière Corps / Bandage	Référence FABRICANT	Référence SEPT
Stab complet Alu / Tophane 100x40 Suspension		8411275 413159	WS86043



Roue motrice Fonte / Vulkollan 230/75 - 5 Trous	8359920 4439920	WM85020
Roue motrice Fonte / Caoutchouc 254/102 - 5 Trous	8425696 5449185	WM85079
Roue motrice Fonte / Vulkollan 250/82 - 5 Trous	8305061	WM85047
Roue motrice Fonte / Vulkollan 250/105 - 5 Trous	8667506	WM85043
Roue motrice Fonte / Caoutchouc 200/80 - Cannelé	4464158	WM85092
Roue motrice Fonte / Vulkollan 200/80 - Cannelé	4464160	WM85042
Roue motrice Fonte / Tophane 200/80 - Cannelé	4464159	WM85095

## TRANSPALETTE MANUELLE

### BT - Galet Roue Directrice



					Matière Corps / Bandage	Référence FABRICANT	Référence SEPT
85	70	12	75	Acier / Vulkollan	150131001	WG88094	
85	70	20	75	Acier / Vulkollan	10099 180135	WG88071	
85	75	-	75	Acier / Vulkollan	31077	WG88128	
85	95	20	100	Acier / Vulkollan	31186	WG88132	
85	75	17	77	Polyamide / Tophane	167610	WG88061	
85	100	17	102	Polyamide / Tophane	167605	WG88120	
85	75	17	75	Acier / Tophane	1594CC	WG88130	
85	100	17	75	Acier / Tophane	1673CC	WG88131	
85	95	20	100	Acier / Vulkollan	47162 10100 150128-095	WG88129	
85	59	17	61	Acier / Vulkollan	1190117	WG88017	



175	50	-	55	Roue Polyamide	47146 102665 103665	WD87006
175	50	-	55	Polyamide / Tophane	47974 129910 156142	WD87016
180	50	20	55	Alu / Caoutchouc	160432	WD87011

## TRANSPALETTE ELECTRIQUE

### BT - Roue Stabilisatrice Motrice Porteuse



					Matière Corps / Bandage	Référence FABRICANT	Référence SEPT
140	60	20	68	Fonte / Tophane	170287	WS86058	
140	68	25	60	Fonte / Tophane	12252	WS86050	
140	60	-	60	Fonte / Tophane	46106 52422	WS86017SR	
125	50	20	50	Fonte / Tophane	156259 171999	WS86031	



Roue motrice Fonte / Tophane 215/70 - 5 Troux	129920 143308 121023	WM85022
Roue motrice Fonte / Vulkollan 250/75 - 5 Troux	138457	WM85016
Roue motrice Fonte / Vulkollan 250/105 - 5 Troux	135161	WM85093
Roue motrice Fonte / Caoutchouc 215/70 - 5 Troux	650719 66215 147214	WM85077







Porteuse diam 230/110 lg 84/25 Fonte / Vulkollan	133163 74256 137584	WP89008
--	---------------------------	---------



# ROULETTE ADAPTABLE Duo

## Roue Jumelée Plastique

Capacité de charge de 40 Kgs

Monture en plastique noir  
 Fixation à platine ou tige filetée ou **tige lisse à clips**  
 Pivotement sur palier lisse  
 Bandage plastique noir  
 Moyeu lisse

				
50	57	20	L11X22	40
50	57	20	L10X30	40
50	62	17	M8x15	40
50	62	20	M8x30	40
50	62	20	M10x15	40

						
50	65	20	38X38	25X25	5	40



SDW410	-
SDW414	-
SDW151	SDW153
SDW154	SDW156
SDW150	SDW152







SDW250	SDW252
--------	--------







# ROULETTE ADAPTABLE Duotec

## Roue Jumelée Polyuréthane

Capacité de charge de 40 à 80 Kgs

Monture en plastique blanc  
 Fixation à platine ou tige filetée ou **tige lisse à clips**  
 Pivotement sur palier lisse  
 Bandage polyuréthane  
 Moyeu lisse

				
50	60	17	<b>L11X22</b>	40
50	56	17	M8x15	40
50	60	17	M8x30	40
75	81	24	M10x25	50
100	107	37	M10x25	60
125	135	50	M10x25	80

						
50	67	17	38X38	25X25	5	40



SDV412



SDV413

SDV151

SDV153

SDV154

SDV156

SDV175

SDV176

SDV100

SDV101

SDV125

SDV126



SDV250







SDV252



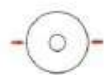

# ROULETTE ADAPTABLE Carénée - Siam

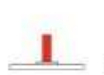



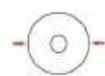

## Roue Caoutchouc Synthétique

Capacité de charge de 40 à 90 Kgs

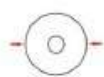
Monture en Tôle d'acier chromée  
 Fixation à oeil ou tige filetée  
 Pivotement sur 2 couronnes de billes  
 Bandage caoutchouc synthétique gris  
 Corps de roue en polypropylène  
 Moyeu à billes ou lisse\*  
 Axe démontable

					
50	68	21	-	8	40
50	68	21	M8x32	-	40
50*	68	21	M8x15	-	50

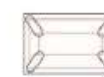
				
50	71	29	10	60
75	98	33	10	90

						
50	73	29	60X60	46x46 à 36x36	6	60
75	100	29	77X76	62x52 à 50x42	8	90



SDC016	-
-	SDC114
-	SDC116



SDX017	SDX018
SDX037	SDX038



SDX217	SDX218
SDX237	SDX238

# ROULETTE MOBILIER - CHARIOTS

## Roue Caoutchouc Synthétique

Capacité de charge de 40 à 70 Kgs

### Roulette économique charge légère

Monture en acier emboutie zinguée

Pivotement sur 2 couronnes de billes

Blocage à double effet sur roue et pivot sauf diam 50 à billes

Roue à bandage caoutchouc synthétique gris non tachant

Corps de roue en plastique

Moyeu lisse\* ou à billes protégé par pare-fils

Axe démontable



50*	72	27	50X50	37X37 à 34X34	6	40
50	70	24	54X54	40X40	6	40
75*	102	33	65X65	53X53 à 43X43	6	50
75	103	37	60X60	47X47 à 37X37	6	50
100*	135	36	75X75	60X60 à 50X50	8	70
100	124	28	60X60	47X47 à 37X37	6	70



50*	69	27	M10	40
50	67	24	M10	40
75*	98	33	M10	50
75	100	37	M10	50
100*	132	36	M12	70
100	121	28	M12	70



SNP217

SNB217

SNP717

SNB717

SNP237

SNB237

SNP737

SNB737

SNP247

SNB247

SNP747

SNB747



SNP017

SNB017

SNP517

SNB517

SNP037

SNB037

SNP537

SNB537

SNP047

SNB047

SNP547

SNB547

# ROULETTE MOBILIER - CHARIOTS

## Roue Caoutchouc Synthétique

Capacité de charge de 75 à 120 Kgs

Monture en acier emboutie zinguée  
 Pivotement sur 2 couronnes de billes  
 Blocage à double effet sur roue et pivot  
 Roue à bandage caoutchouc synthétique gris non tachant  
 Corps de roue en plastique  
 Moyeu à billes protégé par pare-fils  
 Axe démontable  
 Option : Oeil de 10 mm

75	103	30	77X67	61X51 à 50X41	8	75
100	137	40	77X67	61X51 à 50X41	8	100
125	162	43	77X67	61X51 à 50X41	8	100
150	189	51	95X70	75X45 à 72X52	8	120

75	100	30	M12	75
100	134	40	M12	100
125	159	43	M12	100



SPP733

SPB733

SPP743

SPB743

SPP753

SPB753

SPP767

SPB763



SOP733

SOB733

SOP743

SOB743

SOP753

SOB753



# ROULETTE LIT - BRANCARD

## Roue Caoutchouc Synthétique

Capacité de charge de 100 Kgs

Monture en acier emboutie chromée  
 Pivotement sur 2 couronnes de billes  
 Blocage à double effet sur roue et pivot  
 Roue à bandage caoutchouc synthétique gris non tachant  
 Corps de roue en plastique  
 Moyeu à billes protégé par pare-fils  
 Axe démontable

125	175	45	M12	100
150	200	51	M12	100
200	250	54	M12	100

Tige ronde lisse acier  
 Adaptable sur toutes les roulettes à oeil

22	20	45	M12	8
25	20	45	M12	8
27.8	20	45	M12	8



SCP754



SCB754

SCP764

SCB764

SCP774

SCB774



SZ3222

SZ3225





SZ3228

# ROULETTE COMPOSITE

## Roue Caoutchouc Synthétique

Capacité de charge de 90 à 100 Kgs

Monture en Polyamide chargé fibre de verre  
 Pivotement sur roulement à billes  
 Blocage avant à double effet sur roue et pivot  
 Roue à bandage caoutchouc synthétique gris non tachant  
 Corps de roue en plastique  
 Moyeu à billes protégé par pare-fils  
 Axe démontable







				
100	145	38	12	90
125	165	47	12	100



SJP740	SJB740
SJP750	SJB750



SJP741	SJB741
SJP751	SJB751

						
100	149	38	105X80	80X60	9	90
125	169	47	105X80	80X60	9	100

Possibilité de mettre les dimensions de platine à vos mesures

# ROULETTE LIT

## Roue Caoutchouc Synthétique

Capacité de charge de 100 Kgs

Monture en Acier emboutie zinguée

Pivotement sur 2 couronnes de billes ou roulement à billes\*

Blocage:

2 fonctions : Pivotante ou blocage

3 fonctions : Pivotante ou blocage ou blocage directionnel

Roue à bandage caoutchouc synthétique gris non tachant

Corps de roue en plastique

Moyeu à billes protégé par pare-fils - Axe démontable



125	158	45	78.5	100
-----	-----	----	------	-----

150	184	45	78.5	100
-----	-----	----	------	-----

200	184	45	78.5	100
-----	-----	----	------	-----

125	158	51	71	100
-----	-----	----	----	-----

150	184	51	71	100
-----	-----	----	----	-----



125*	175	45	78.5	100
------	-----	----	------	-----

150*	200	51	78.5	100
------	-----	----	------	-----

200*	250	54	78.5	100
------	-----	----	------	-----



2 Fonctions  
45°

3 Fonctions  
45°

STB258	STD258
--------	--------

STB268	STD268
--------	--------

STB278	STD278
--------	--------

STB251	STD251
--------	--------

STB261	STD261
--------	--------

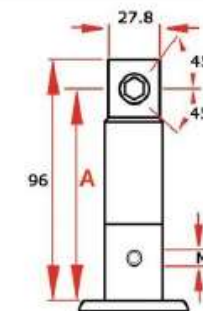

2 Fonctions  
45°

3 Fonctions  
45°

STB758	STD758
--------	--------

STB768	STD768
--------	--------

STB778	STD778
--------	--------

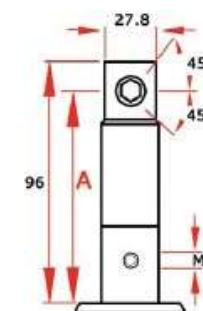

# ROULETTE LIT

## Roue Polyuréthane gris

Capacité de charge de 100 à 150 Kgs

Monture en Polyamide sur une armature en acier

Pivotement sur roulement à billes

Blocage:





2 fonctions : Pivotante ou blocage



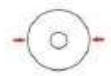

3 fonctions : Pivotante ou blocage ou blocage directionnel

Roue à bandage polyuréthane gris non tachant

Corps de roue en plastique

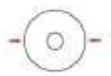
Moyeu à billes protégé par pare-fils - Axe démontable

			<b>A</b>	
125	158	40	78.5	150
150	188	42	78.5	150
200	229	56	78.5	150

			<b>A</b>	
125	165	30	78.5	100
150	190	60	78.5	120

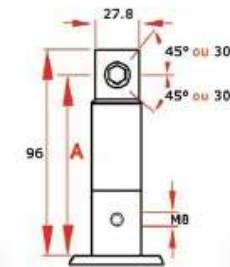

2 Fonctions 45°	3 Fonctions 45°
STB858	STD858
STB868	STD868
STB878	STD878

2 Fonctions 30°	3 Fonctions 30°
STB857	STD857
STB867	STD867
STB877	STD877

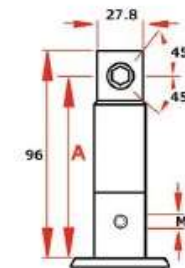





2 Fonctions 45°	3 Fonctions 45°
STB859	STD859
STB869	STD869

# BANDAGE FAUTEUIL - BRANCARD





## Roue Caoutchouc Synthétique

Capacité de charge de 70 Kgs

Monture en acier emboutie chromée  
 Pivotement sur 1 roulement à billes  
 Roue à bandage caoutchouc synthétique gris non tachant  
 Bandage increvable  
 Corps de roue en plastique  
 Moyeu à billes  
 Axe démontable

				
150	175	42	M12	70
200	230	56	M12	70

Roue à bandage caoutchouc synthétique gris non tachant  
 Bandage increvable  
 Corps de roue en plastique pour la référence R7020  
 Moyeu à billes pour les références R7721 et R7020

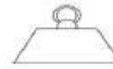
				
200	30	8	60	70
600	30	12	60	70
600	30	24x1 <sup>3</sup> / <sub>8</sub>		70



SOS760

SOS770



SR7721



SR7020



SR7000

SR7721	-	-
-	SR7020	-
-	-	SR7000

# ROULETTE INOX MOBILIER - CHARIOTS

## Roue Caoutchouc Synthétique

Capacité de charge de 50 à 100 Kgs

Monture en tôle d'acier Inox 304  
 Pivotement sur 2 couronnes de billes Inox protégé  
 Blocage avant à double effet sur roue et pivot  
 Roue à bandage caoutchouc synthétique gris  
 Corps de roue en plastique  
 Moyeu lisse  
 Axe démontable  
 Température d'utilisation de -10°C à +70°C



50	74	25	60x60	49x49 à 43x43	6	60
75	101	31	60x60	49x49 à 43x43	6	60
100	124	40	60x60	49x49 à 43x43	6	70
100	132	40	90x70	75x55 à 65x45	8	90
125	157	40	90x70	75x55 à 65x45	8	100



50	70	26	M12	40
63	90	26	M12	60
75	101	30	M10	60
100	131	40	M12	80
125	148	43	M12	90
150	181	45	M12	100



SIP210	SIF210	SIB210
SIP230	SIF230	SIB230
SIP240	SIF240	SIB240
SIP241	SIF241	SIB241
SIP251	SIF251	SIB251



SJP210	SJB210
SJP220	SJB220
SJP230	SJB230
SJP240	SJB240
SJP250	SJB250
SJP260	SJB260

## ROUES SEULES

### Roue Caoutchouc Synthétique

Capacité de charge de 40 à 120 Kgs

Roue à bandage caoutchouc synthétique gris non tachant  
Bandage souple et silencieux  
Corps de roue en plastique ou acier référence R7722  
Moyeu lisse ou à billes\*  
Roue moyeu lisse livrée sans pare-fils



50	18	6	22	40
50*	18	8	22	40
50	18	8	22	40
75	23	8	28	50
75*	23	8	28	50
80*	30	8	38	100
100	30	12	38	100
100*	30	8	38	100
125	32	12	38	100
125*	32	8	38	100
150*	32	8	38	120
200*	32	8	38	120



SR7101  
SR7102  
SR7103  
SR7301  
SR7302  
SR7304  
SR7401  
SR7402  
SR7501  
SR7502  
SR7602  
SR7702

# FIXATION - BUTOIR ANNULAIRE

## Tube rond

Fixation expansible en plastique  
Dimension **intérieure** du tube en mm

OPTION : Vis Inox

Oeil de réduction de 12 à 10 mm en Inox



Dimension Intérieure	Diamètre Vis	Référence
19 à 21	M10	SZ0018
21 à 24	M10	SZ0022
24 à 27	M10	SZ0024
27 à 30	M10	SZ0026
30 à 35	M10	SZ0031

Butoir annulaire en caoutchouc  
Dimension **extérieure** du tube en mm



Diamètre Extérieur	Diamètre Tube	Référence
95	22	SZ1922
95	25	SZ1925
95	32	SZ1932

Fixation expansible en plastique  
Dimension **intérieure** du tube en mm

OPTION : Vis Inox

Oeil de réduction 12 à 10 mm en Inox



Dimension Intérieure	Diamètre Vis	Référence
21 à 24	M10	SZ4022
24 à 27	M10	SZ4025
27 à 30	M10	SZ4027
32 à 35	M10	SZ4032
36 à 40	M10	SZ4035

Butoir annulaire en caoutchouc  
Dimension **extérieure** du tube en mm



Diamètre Extérieur	Section Tube	Référence
95	25x25	SZ5925
95	30x30	SZ5930
95	32x32	SZ5932